



LAD Series User Manual



Economical Security/Fire Alarm PSU with Battery Charger/UPS



LAD series is an economical AC/DC low profile security power supply with UPS function. Adopting the input range from 90Vac to 264Vac (LAD-120~600:115Vac selectable by switch; LAD-120:90Vac full range input) and supports output 27.6Vdc, 41.5Vdc and 55.2Vdc. With high efficiency up to 86.5% and built-in AC, battery switch for easy maintenance. In addition, LAD-600 series not only provide TTL signals for AC OK, battery disconnect, battery reverse polarity (No damage), battery low detection, battery full and discharge, but also possess UART version so the users can monitor and control the status of the units, that enhance easy way for integration into security and fire systems directly.

Content:

1. Safety Guidelines	1
2. Introduction	2
2.1 Model number	2
2.2 Features	2
2.3 Electrical specification	3
2.4 Safety regulations	9
2.5 Derating curve & static characteristic curve	9
2.6 Mechanical specification	10
3. Installation & Introduction	12
3.1 Installation requirements	12
3.2 Torque specification of the fixing holes of the case	12
3.3 Wiring use	13
3.4 Installation steps	13
3.5 Instructions for battery serial and parallel use	14
4. User Interface Panel	15
4.1 Panel description	15
4.2 Pin assignment	16
5. Function Description	18
5.1 DC-UPS function	18
5.2 UART communication function(U version)	19
5.3 TTL function signal(Blank version)	23
5.4 Communication monitoring function (for details)	26
6. Protections and Failure Correction	41
6.1 Protections	41
6.2 Failure correction	42
7. Warranty	43
8. Environmental declaration information	44

1. Safety Guidelines

- Risk of electrical shock and energy hazard. All failure should be examined by a qualified technician. Please do not remove the case of the power supply by yourself!
- Please do not install power supplies in places with high moisture or near the water.
- Please do not install power supplies in places with high ambient temperature or near fire source. The maximum ambient temperature please refer to their specifications.
- Output current and output wattage must not exceed the rated values on specifications.
- The ground(FG) must be connected to earth ground.
- The protective earthing is used as a safeguard, the instructions shall require connection of the equipment protective earthing conductor to the installation protective earthing conductor (for example, by means of a power cord connected to a socket-outlet with earthing connection).
- Notices for battery application
 - a. Make sure charging voltage and current meet battery's specification.
 - b. Refrain from connecting new and old batteries in series.
 - c. The cables between power supply and battery should be kept as short as possible to prevent excessive voltage drop (suggested cable length: 50cm ~1000cm). Too much voltage drop will lead to longer charging period.
 - d. The power supply is suitable for lead-acid batteries (flooded water type, gel colloid type, AGM adsorption glass fiber...etc) or lithium batteries (lithium ion, lithium manganese, lithium ternary...etc).

2. Introduction

2.1 Model number

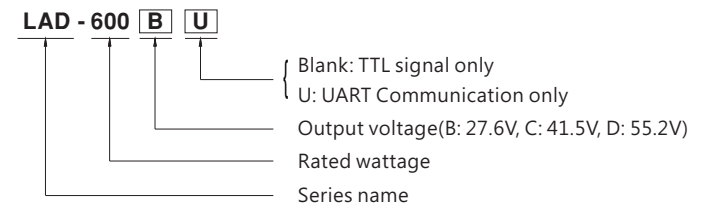

2.2 Features

- Built-in AC and battery circuit ON/OFF switches enhance safeness during maintenance.
- Built-in AC OK, Battery disconnect Battery reverse polarity, Battery low, Battery full and Discharge (Blank version only).
- Protections: Short circuit Overload/ Over voltage /Over temperature /Battery low/ Battery reverse polarity (no damage).
- Forced UPS mode for battery maintenance and improve battery life
- UART Communication (U version only)
- Built-in buzzer alarm (U version only)
- -20~ +60°C wide operating temperature
- Suitable for lead acid and lithium-ion batteries
- UL/CE/UKCA/EAC certified, Design refer to GB17945/GB4717(U version only)
- 3 years warranty

2.3 Electrical Specification

LAD-120 Series

MODEL	LAD-120A	LAD-120B	LAD-120C	LAD-120D	
OUTPUT	OUTPUT NUMBER	CH1 CH2	CH1 CH2	CH1 CH2	
	DC VOLTAGE	13.8V 13.8V	27.6V 27.6V	41.5V 41.5V	
	RATED CURRENT	7.7A 1A(Battery Charger)	3.4A 1A(Battery Charger)	1.9A 1A(Battery Charger)	
	CURRENT RANGE	0 ~ 8.7A	0 ~ 4.4A	0 ~ 2.9A	
	RATED POWER	120W	121.4W	120.35W	
	RIPPLE & NOISE (max.) Note 2	120mVp-p	150mVp-p	240mVp-p	
	VOLTAGE ADJ. RANGE	CH1: 10.8 ~ 14.5V	CH1: 21.6 ~ 29V	CH1: 32.4 ~ 43.5V	
	VOLTAGE TOLERANCE Note 3	±1.0%	±1.0%	±1.0%	
	LINE REGULATION	±0.5%	±0.5%	±0.5%	
	LOAD REGULATION	±0.5%	±0.5%	±0.5%	
SETUP, RISE TIME	500ms, 40ms/230VAC	500ms, 40ms/115VAC at full load			
HOLD UP TIME (Typ.)	40ms/230VAC	9ms/115VAC at full load			
BATTERY STATIC DISCHARGE CURRENT	<100µA				
INPUT	VOLTAGE RANGE	90 ~ 264VAC	127 ~ 370VDC		
	FREQUENCY RANGE	47 ~ 63Hz			
	EFFICIENCY (Typ.)	86%	88%	88%	88%
	AC CURRENT (Typ.)	2.5A/115VAC	1.5A/230VAC		
	INRUSH CURRENT (Typ.)	COLD START 30A/115VAC		55A/230VAC	
	LEAKAGE CURRENT	0.5mA / 240VAC			
PROTECTION	OVERLOAD	CH1:105 ~ 135% CH2:90 ~ 110% Protection type: CH1 OLP, CH2 with battery. The unit enters to UPS mode when CH1 is around 105%~120%, when total output of CH1 + CH2 reach around 125%~135% output hiccup (120D shuts down) CH1 OLP, CH2 without battery; hiccup mode of p voltage (120D shuts down), re-power on to removed CH2: Constant current limiting; fault condition does not affect CH1 working, recovers automatically after fault condition is removed (External fuse is mandatory in series connection with battery for protection)			
	OVER VOLTAGE	CH1:15.5 ~ 18V	CH1:31 ~ 36V	CH1:47 ~ 55V	CH1:61 ~ 71V
	OVER TEMPERATURE	Protection type: Shut down o/p voltage, re-power on to removed			
	BATTERY REVERSE POLARITY	Protected when reverse polarity, no damage, recovers automatically after fault condition is removed			
	BATTERY CUTOFF	9.5V±0.5V	21.5V±0.5V	32V±0.5V	43V±0.5V
FUNCTION	AC OK	TTL signal, High / Open : AC OK ; Low : AC Fail ; Ice : max. 30mA@ 50VDC			
	BATTERY DISCONNECT/ REVERSE POLARITY	TTL signal, High / Open : Battery disconnect/reverse polarity ; Low : Battery connect/normal; Ice : max. 30mA@ 50VDC			
	BATTERY LOW	TTL signal, High / Open : Battery low ; Low : Battery normal; Ice : max. 30mA@ 50VDC			
	BATTERY FULL	TTL signal, High / Open : Battery full ; Low : Battery charging ; Ice : max. 30mA@ 50VDC			
ENVIRONMENT	DISCHARGE	TTL signal, High / Open : Discharge Low ; Charge ; Ice : max. 30mA@ 50VDC			
	WORKING TEMP.	-20 ~ +60°C (Refer to "Derating Curve")			
	WORKING HUMIDITY	20 ~ 95% RH non-condensing			
	STORAGE TEMP., HUMIDITY	-30 ~ +85°C, 10 ~ 95% RH non-condensing			
SAFETY & EMC (Note 4)	TEMP. COEFFICIENT	±0.03%/°C (0 ~ 50°C)			
	VIBRATION	10 ~ 500Hz, 5G 10min./1cycle, 60min. each along X, Y, Z axes			
	SAFETY STANDARDS	UL62368-1, BS EN/EN62368-1, AS/NZS62368.1, EAC TP TC 004 approved; Design refer to GB 17945-2010			
	WITHSTAND VOLTAGE	I/P-O/P:3KVAC I/P-FG:2KVAC O/P-FG:0.5KVAC			
	ISOLATION RESISTANCE	I/P-O/P, I/P-FG, O/P-FG:100M Ohms / 500VDC / 25 °C 70% RH			
	EMC EMISSION	Parameter	Standard	Test Level / Note	
		Conducted	BS EN/EN55032 (CISPR32), EAC TP TC 020	Class A	
		Radiated	BS EN/EN55032 (CISPR32), EAC TP TC 020	Class A	
		Harmonic Current (Note 5)	BS EN/EN61000-3-2	Class A	
		Voltage Flicker	-----	-----	
EMC IMMUNITY	Parameter	Standard	Test Level / Note		
	ESD	BS EN/EN61000-4-2	Level 3, 8KV air ; Level 2, 6KV contact; criteria A		
	Radiated	BS EN/EN61000-4-3	Level 3, 10V/m ; criteria A		
	EFT / Burst	BS EN/EN61000-4-4	Level 3, 2KV ; criteria A		
	Surge	BS EN/EN61000-4-5	Level 3, 1KV/Line-Line; 2KV/Line-FG ; criteria A		
	Conducted	BS EN/EN61000-4-6	Level 3, 10V ; criteria A		
Magnetic Field	BS EN/EN61000-4-8	Level 4, 30A/m ; criteria A			
OTHERS	MTBF	1509.9K hrs min. Telcordia SR-332 (Bellcore);	209.4K hrs min.	MIL-HDBK-217F (25)	
	DIMENSION	159*97*30mm (L*W*H)			
	PACKING	0.42Kg; 30pcs/13.6Kg/0.77CUFT			

LAD-240 Series

MODEL	LAD-240A	LAD-240B	LAD-240C	LAD-240D	
OUTPUT	OUTPUT NUMBER	CH1 CH2	CH1 CH2	CH1 CH2	
	DC VOLTAGE	13.8V 13.8V	27.6V 27.6V	41.5V 41.5V	
	RATED CURRENT	16.4A 1A(Battery Charger)	7.7A 1A(Battery Charger)	4.78A 1A(Battery Charger)	
	CURRENT RANGE	0 ~ 17.4A	0 ~ 8.7A	0 ~ 5.78A	
	RATED POWER	240.12W	240.12W	239.87W	
	RIPPLE & NOISE (max.) Note 2	150mVp-p	150mVp-p	240mVp-p	
	VOLTAGE ADJ. RANGE	CH1: 10.8 ~ 14.5V	CH1: 21.6 ~ 29V	CH1: 32.4 ~ 43.5V	
	VOLTAGE TOLERANCE Note 3	±1.5%	±1.0%	±1.0%	
	LINE REGULATION	±0.5%	±0.5%	±0.5%	
	LOAD REGULATION	±1.0%	±0.5%	±0.5%	
SETUP, RISE TIME	2000ms, 50ms/230VAC	2000ms, 50ms/115VAC at full load			
HOLD UP TIME (Typ.)	16ms/230VAC	12ms/115VAC at full load			
BATTERY STATIC DISCHARGE CURRENT	<100µA				
INPUT	VOLTAGE RANGE	90 ~ 132VAC / 180 ~ 264VAC by switch	240 ~ 370VDC (Default switch at 230VAC)		
	FREQUENCY RANGE	47 ~ 63Hz			
	EFFICIENCY (Typ.)	85.5%	87.5%	88%	88%
	AC CURRENT (Typ.)	4.4A/115VAC	2.4A/230VAC		
	INRUSH CURRENT (Typ.)	COLD START 60A/115VAC		60A/230VAC	
	LEAKAGE CURRENT	<0.5mA / 240VAC			
PROTECTION	OVERLOAD	CH1:105 ~ 135% CH2:90 ~ 110% Protection type: CH1 OLP, CH2 with battery; the unit will enter to UPS mode when CH1 is around 105%~120%, when total output of CH1 + CH2 reach around 125%~135% output shuts down CH1 OLP, CH2 without battery; Shut down o/p voltage, re-power on to removed CH2: Constant current limiting; fault condition does not affect CH1 working, recovers automatically after fault condition is removed (External fuse is mandatory in series connection with battery for protection)			
	OVER VOLTAGE	CH1:15.5 ~ 18V	CH1:31 ~ 36V	CH1:47 ~ 55V	CH1:59 ~ 69V
	OVER TEMPERATURE	Protection type: Shut down o/p voltage, re-power on to removed			
	BATTERY REVERSE POLARITY	Protected when reverse polarity, no damage, recovers automatically after fault condition is removed			
	BATTERY CUTOFF	9.5V±0.5V	21.5V±0.5V	32V±0.5V	43V±0.5V
FUNCTION	AC OK	TTL signal, High / Open : AC OK ; Low : AC Fail ; Ice : max. 30mA@ 50VDC			
	BATTERY DISCONNECT/ REVERSE POLARITY	TTL signal, High / Open : Battery disconnect/reverse polarity ; Low : Battery connect/normal; Ice : max. 30mA@ 50VDC			
	BATTERY LOW	TTL signal, High / Open : Battery low ; Low : Battery normal; Ice : max. 30mA@ 50VDC			
	BATTERY FULL	TTL signal, High / Open : Battery full ; Low : Battery charging ; Ice : max. 30mA@ 50VDC			
ENVIRONMENT	DISCHARGE	TTL signal, High / Open : Discharge Low ; Charge ; Ice : max. 30mA@ 50VDC			
	WORKING TEMP.	-20 ~ +60°C (Refer to "Derating Curve")			
	WORKING HUMIDITY	20 ~ 95% RH non-condensing			
	STORAGE TEMP., HUMIDITY	-30 ~ +85°C, 10 ~ 95% RH non-condensing			
SAFETY & EMC (Note 4 & 5)	TEMP. COEFFICIENT	±0.03%/°C (0 ~ 50°C)			
	VIBRATION	10 ~ 500Hz, 5G 10min./1cycle, 60min. each along X, Y, Z axes			
	SAFETY STANDARDS	UL62368-1, BS EN/EN62368-1, AS/NZS62368.1, EAC TP TC 004 approved; Design refer to GB 17945-2010			
	WITHSTAND VOLTAGE	I/P-O/P:3KVAC I/P-FG:2KVAC O/P-FG:0.5KVAC			
	ISOLATION RESISTANCE	I/P-O/P, I/P-FG, O/P-FG:100M Ohms / 500VDC / 25 °C 70% RH			
	EMC EMISSION	Parameter	Standard	Test Level / Note	
		Conducted	BS EN/EN55032 (CISPR32), EAC TP TC 020	Class A	
		Radiated	BS EN/EN55032 (CISPR32), EAC TP TC 020	Class A	
		Harmonic Current	-----	-----	
		Voltage Flicker	-----	-----	
EMC IMMUNITY	Parameter	Standard	Test Level / Note		
	ESD	BS EN/EN61000-4-2	Level 3, 8KV air ; Level 2, 6KV contact; criteria A		
	Radiated	BS EN/EN61000-4-3	Level 3, 10V/m ; criteria A		
	EFT / Burst	BS EN/EN61000-4-4	Level 3, 2KV ; criteria A		
	Surge	BS EN/EN61000-4-5	Level 3, 1KV/Line-Line; 2KV/Line-FG ; criteria A		
	Conducted	BS EN/EN61000-4-6	Level 3, 10V ; criteria A		
Magnetic Field	BS EN/EN61000-4-8	Level 4, 30A/m ; criteria A			
OTHERS	MTBF	1394.9K hrs min. Telcordia SR-332 (Bellcore);	156.7K hrs min.	MIL-HDBK-217F (25)	
	DIMENSION	215*115*30mm (L*W*H)			
	PACKING	0.75Kg; 15pcs/12.25Kg/0.77CUFT			

LAD-360xU Series UART Communication Function Model(U Version)

MODEL	LAD-360BU		LAD-360CU		LAD-360DU		
OUTPUT	OUTPUT NUMBER	CH1	CH2	CH1	CH2	CH1	CH2
	DC VOLTAGE	27.6V	27.6V	41.5V	41.5V	55.2V	55.2V
	RATED CURRENT	11.5A	1.5A(Battery Charger)	7.14A	1.5A(Battery Charger)	5.03A	1.5A(Battery Charger)
	CURRENT RANGE	0 ~ 13A	-----	0 ~ 8.64A	-----	0 ~ 6.53A	-----
	RATED POWER	358.8W	-----	358.56W	-----	360.46W	-----
	RIPPLE & NOISE (max.) Note.2	150mVp-p	-----	240mVp-p	-----	240mVp-p	-----
	VOLTAGE ADJ. RANGE	CH1: 21.6 ~ 29V	-----	CH1: 32.4 ~ 43.5V	-----	CH1: 43.5 ~ 58V	-----
	VOLTAGE TOLERANCE Note.3	±1.0%	-----	±1.0%	-----	±0.5%	-----
	LINE REGULATION	±0.5%	-----	±0.5%	-----	±0.5%	-----
	LOAD REGULATION	±0.5%	-----	±0.5%	-----	±0.5%	-----
	SETUP, RISE TIME	200ms, 50ms/230VAC	200ms, 50ms/115VAC at full load	-----	-----	-----	-----
	HOLD UP TIME (Typ.)	16ms/230VAC	12ms/115VAC at full load	-----	-----	-----	-----
	BATTERY STATIC DISCHARGE CURRENT	<100μA	-----	-----	-----	-----	-----
INPUT	VOLTAGE RANGE	90 ~ 132VAC / 180 ~ 264VAC by switch		240 ~ 370VDC (Default switch at 230VAC)			
	FREQUENCY RANGE	47 ~ 63Hz					
	EFFICIENCY (Typ.)	86%		86.5%		86.5%	
	AC CURRENT (Typ.)	8A/115VAC	4A/230VAC	-----		-----	
	INRUSH CURRENT (Typ.)	COLD START 60A/115VAC		60A/230VAC			
	LEAKAGE CURRENT	<0.5mA/240VAC					
PROTECTION	OVERLOAD	CH1:105 ~ 135% CH2:90 ~ 110% Protection type: CH1 OLP, CH2 with battery: hñ unit will enter to UPS mode when CH1 is around 105%~120%, when total output of CH1 + CH2 reach around 125%~135% output shuts down CH1 OLP, CH2 without battery: Shut down o/p voltage, re-power on to removed CH2: Constant current limiting; fault condition does not affect CH1 working, recovers automatically after fault condition is removed (External fuse is mandatory in series connection with battery for protection)					
	OVER VOLTAGE	CH1:31 ~ 36V	-----	CH1:47 ~ 55V	-----	CH1:59 ~ 69V	-----
	OVER TEMPERATURE	Protection type: Shut down o/p voltage, re-power on to removed					
	BATTERY REVERSE POLARITY	Protected when reverse polarity , no damage, recovers automatically after fault condition is removed					
	BATTERY CUTOFF	21.5V±0.5V	-----	32V±0.5V	-----	43V±0.5V	-----
	AC OK	115VAC Input : Signals AC failure and activates when input voltage <75VAC Recover the main power supply when input voltage >85VAC 230VAC Input : Signals AC failure and activates when input voltage <165VAC Recover the main power supply when input voltage >175VAC					
FUNCTION	CHARGER CIRCUIT FAIL	Battery disconnected, battery reverse polarity signal failure					
	BUZZER ALARM	Battery low(fire alarm system selectable by UART) AC fail, Battery low, battery disconnected , battery reverse connect, overload status (evacuation system selectable byUART)					
	WORKING TEMP.	-20 ~ +60°C (Refer to "Derating Curve")					
ENVIRONMENT	WORKING HUMIDITY	20 ~ 95% RH non-condensing					
	STORAGE TEMP., HUMIDITY	-30 ~ +85°C, 10 ~ 95% RH non-condensing					
	TEMP. COEFFICIENT	±0.03%/°C (0 ~ 50°C)					
SAFETY & EMC (Note 4 & 5)	VIBRATION	10 ~ 500Hz, 5G 10min./1cycle, 60min. each along X, Y, Z axes					
	SAFETY STANDARDS	UL62368-1, BS EN/EN62368-1, AS/NZS62368.1, EAC TP TC 004 approved; Design refer to GB 17945-2010, GB4717					
	WITHSTAND VOLTAGE	I/P-O/P:3KVAC I/P-FG:2KVAC O/P-FG:0.5KVAC					
	ISOLATION RESISTANCE	I/P-O/P, I/P-FG, O/P-FG:100M Ohms / 500VDC / 25 °C 70% RH					
	EMC EMISSION	Parameter	Standard	Test Level / Note			
		Conducted	BS EN/EN55032 (CISPR32), EAC TP TC 020	Class A			
		Radiated	BS EN/EN55032 (CISPR32), EAC TP TC 020	Class A			
		Harmonic Current	-----	-----			
		Voltage Flicker	-----	-----			
	EMC IMMUNITY	Parameter	Standard	Test Level / Note			
ESD		BS EN/EN61000-4-2	Level 3, 8KV air ; Level 2, 6KV contact; criteria A				
Radiated		BS EN/EN61000-4-3	Level 3, 10V/m ; criteria A				
EFT / Burst		BS EN/EN61000-4-4	Level 3, 2KV ; criteria A				
Surge		BS EN/EN61000-4-5	Level 3, 1KV/Line-Line ; 2KV/Line-FG ; criteria A				
OTHERS	Conducted	BS EN/EN61000-4-6		Level 3, 10V ; criteria A			
	Magnetic Field	BS EN/EN61000-4-8		Level 4, 30A/m ; criteria A			
	MTBF	1394.9K hrs min. Telcordia SR-332 (Bellcore);	153.3K hrs min. MIL-HDBK-217F (25)	-----			
DIMENSION	215*115*30mm (L*W*H)						
PACKING	0.75Kg, 15pcs/12.25Kg/0.7CUFT						

LAD-360x Series TTL Communication Function Model(Blank Version)

MODEL	LAD-360B		LAD-360C		LAD-360D		
OUTPUT	OUTPUT NUMBER	CH1	CH2	CH1	CH2	CH1	CH2
	DC VOLTAGE	27.6V	27.6V	41.5V	41.5V	55.2V	55.2V
	RATED CURRENT	11.5A	1.5A(Battery Charger)	7.14A	1.5A(Battery Charger)	5.03A	1.5A(Battery Charger)
	CURRENT RANGE	0 ~ 13A	-----	0 ~ 8.64A	-----	0 ~ 6.53A	-----
	RATED POWER	358.8W	-----	358.56W	-----	360.46W	-----
	RIPPLE & NOISE (max.) Note.2	150mVp-p	-----	240mVp-p	-----	240mVp-p	-----
	VOLTAGE ADJ. RANGE	CH1: 21.6 ~ 29V	-----	CH1: 32.4 ~ 43.5V	-----	CH1: 43.5 ~ 58V	-----
	VOLTAGE TOLERANCE Note.3	±1.0%	-----	±1.0%	-----	±0.5%	-----
	LINE REGULATION	±0.5%	-----	±0.5%	-----	±0.5%	-----
	LOAD REGULATION	±0.5%	-----	±0.5%	-----	±0.5%	-----
	SETUP, RISE TIME	200ms, 50ms/230VAC	200ms, 50ms/115VAC at full load	-----	-----	-----	-----
	HOLD UP TIME (Typ.)	16ms/230VAC	12ms/115VAC at full load	-----	-----	-----	-----
	BATTERY STATIC DISCHARGE CURRENT	<100μA	-----	-----	-----	-----	-----
INPUT	VOLTAGE RANGE	90 ~ 132VAC / 180 ~ 264VAC by switch		240 ~ 370VDC (Default switch at 230VAC)			
	FREQUENCY RANGE	47 ~ 63Hz					
	EFFICIENCY (Typ.)	86%		86.5%		86.5%	
	AC CURRENT (Typ.)	8A/115VAC	4A/230VAC	-----		-----	
	INRUSH CURRENT (Typ.)	COLD START 60A/115VAC		60A/230VAC			
	LEAKAGE CURRENT	<0.5mA/240VAC					
PROTECTION	OVERLOAD	CH1:105 ~ 135% CH2:90 ~ 110% Protection type: CH1 OLP, CH2 with battery: hñ unit will enter to UPS mode when CH1 is around 105%~120%, when total output of CH1 + CH2 reach around 125%~135% output shuts down CH1 OLP, CH2 without battery: Shut down o/p voltage, re-power on to removed CH2: Constant current limiting; fault condition does not affect CH1 working, recovers automatically after fault condition is removed (External fuse is mandatory in series connection with battery for protection)					
	OVER VOLTAGE	CH1:31 ~ 36V	-----	CH1:47 ~ 55V	-----	CH1:59 ~ 69V	-----
	OVER TEMPERATURE	Protection type: Shut down o/p voltage, re-power on to removed					
	BATTERY REVERSE POLARITY	Protected when reverse polarity , no damage, recovers automatically after fault condition is removed					
	BATTERY CUTOFF	21.5V±0.5V	-----	32V±0.5V	-----	43V±0.5V	-----
	AC OK	TTL signal, High / Open : AC OK ; Low : AC Fail ; Ice : max. 30mA@ 50VDC					
FUNCTION	BATTERY DISCONNECT/ REVERSE POLARITY	TTL signal, High / Open : Battery disconnect/reverse polarity ; Low : Battery connect/normal; Ice : max. 30mA@ 50VDC					
	BATTERY LOW	TTL signal, High / Open : Battery low ; Low : Battery normal; Ice : max. 30mA@ 50VDC					
	BATTERY FULL	TTL signal, High / Open : Battery full ; Low : Battery charging ; Ice : max. 30mA@ 50VDC					
	DISCHARGE	TTL signal, High / Open : Discharge ; Low : Charge ; Ice : max. 30mA@ 50VDC					
ENVIRONMENT	WORKING TEMP.	-20 ~ +60°C (Refer to "Derating Curve")					
	WORKING HUMIDITY	20 ~ 95% RH non-condensing					
	STORAGE TEMP., HUMIDITY	-30 ~ +85°C, 10 ~ 95% RH non-condensing					
TEMP. COEFFICIENT	±0.03%/°C (0 ~ 50°C)						
SAFETY & EMC (Note 4 & 5)	VIBRATION	10 ~ 500Hz, 5G 10min./1cycle, 60min. each along X, Y, Z axes					
	SAFETY STANDARDS	UL62368-1, BS EN/EN62368-1, AS/NZS62368.1, EAC TP TC 004 approved; Design refer to GB 17945-2010					
	WITHSTAND VOLTAGE	I/P-O/P:3KVAC I/P-FG:2KVAC O/P-FG:0.5KVAC					
	ISOLATION RESISTANCE	I/P-O/P, I/P-FG, O/P-FG:100M Ohms / 500VDC / 25 °C 70% RH					
	EMC EMISSION	Parameter	Standard	Test Level / Note			
		Conducted	BS EN/EN55032 (CISPR32), EAC TP TC 020	Class A			
		Radiated	BS EN/EN55032 (CISPR32), EAC TP TC 020	Class A			
		Harmonic Current	-----	-----			
		Voltage Flicker	-----	-----			
	EMC IMMUNITY	Parameter	Standard	Test Level / Note			
ESD		BS EN/EN61000-4-2	Level 3, 8KV air ; Level 2, 6KV contact; criteria A				
Radiated		BS EN/EN61000-4-3	Level 3, 10V/m ; criteria A				
EFT / Burst		BS EN/EN61000-4-4	Level 3, 2KV ; criteria A				
Surge		BS EN/EN61000-4-5	Level 3, 1KV/Line-Line ; 2KV/Line-FG ; criteria A				
OTHERS	Conducted	BS EN/EN61000-4-6		Level 3, 10V ; criteria A			
	Magnetic Field	BS EN/EN61000-4-8		Level 4, 30A/m ; criteria A			
	MTBF	1160.5K hrs min. Telcordia SR-332 (Bellcore);	126.5K hrs min. MIL-HDBK-217F (25)	-----			
DIMENSION	215*115*30mm (L*W*H)						
PACKING	0.75Kg, 15pcs/12.25Kg/0.7CUFT						

LAD-600xU Series UART Communication Function Model(U Version)

MODEL	LAD-600BU		LAD-600CU		LAD-600DU		
OUTPUT	OUTPUT NUMBER	CH1	CH2	CH1	CH2	CH1	CH2
	DC VOLTAGE	27.6V	27.6V	41.5V	41.5V	55.2V	55.2V
	RATED CURRENT	18.74A	3A(Battery Charger)	11.45A	3A(Battery Charger)	7.87A	3A(Battery Charger)
	CURRENT RANGE	0 ~ 21.74A	-----	0 ~ 14.45A	-----	0 ~ 10.87A	-----
	RATED POWER	600.02W	-----	599.67W	-----	600.02W	-----
	RIPPLE & NOISE (max.) Note.2	270mVp-p	-----	360mVp-p	-----	360mVp-p	-----
	VOLTAGE ADJ. RANGE	CH1: 21.6 ~ 29V	-----	CH1: 32.4 ~ 43.5V	-----	CH1: 43.5 ~ 58V	-----
	VOLTAGE TOLERANCE Note.3	±1.0%	-----	±1.0%	-----	±1.0%	-----
	LINE REGULATION	±0.5%	-----	±0.5%	-----	±0.5%	-----
	LOAD REGULATION	±0.5%	-----	±0.5%	-----	±0.5%	-----
	SETUP, RISE TIME	2000ms, 50ms/230VAC	2000ms, 50ms/115VAC at full load				
	HOLD UP TIME (Typ.)	16ms/230VAC	12ms/115VAC at full load				
INPUT	BATTERY STATIC DISCHARGE CURRENT	<100µA					
	VOLTAGE RANGE	90 ~ 132VAC / 180 ~ 264VAC by switch		240 ~ 370VDC (Default switch at 230VAC)			
	FREQUENCY RANGE	47 ~ 63Hz					
	EFFICIENCY (Typ.)	90%		91%		91%	
	AC CURRENT (Typ.)	12A/115VAC 7.5A/230VAC					
	INRUSH CURRENT (Typ.)	COLD START 35A/115VAC 60A/230VAC					
	LEAKAGE CURRENT	<0.5mA Peak / 240VAC					
PROTECTION	OVERLOAD Note.4	CH1:105 ~ 135% CH2:90 ~ 110% Protection type : CH1 OLP, CH2 with battery: The unit will enter to UPS mode when CH1 is around 105%~120%, when total output of CH1 + CH2 reach around 125%~135% output shuts down CH1 OLP, CH2 without battery: Shut down o/p voltage, re-power on to removed CH2 : Constant current limiting; fault condition does not affect CH1 working, recovers automatically after fault condition is removed (External fuse is mandatory in series connection with battery for protection)					
	OVER VOLTAGE Note.4	CH1:31 ~ 36V		CH1:47 ~ 55V		CH1:59 ~ 69V	
	OVER TEMPERATURE Note.4	Protection type : Shut down o/p voltage, re-power on to removed					
	BATTERY REVERSE POLARITY	Protected when reverse polarity , no damage, recovers automatically after fault condition is removed					
	BATTERY CUTOFF	21.5V±0.5V		32V±0.5V		43V±0.5V	
FUNCTION	AC OK	115VAC Input : Signals AC failure and activates when input voltage <75VAC Recover the main power supply when input voltage >87VAC 230VAC Input : Signals AC failure and activates when input voltage <165VAC Recover the main power supply when input voltage >175VAC					
	CHARGER CIRCUIT FAIL	Battery disconnected battery reverse polarity signal failure					
	BUZZER ALARM	Battery low/ fire alarm system selectable by UART					
	WORKING TEMP.	-20 ~ +60°C (Refer to "Derating Curve")					
ENVIRONMENT	WORKING HUMIDITY	20 ~ 95% RH non-condensing					
	STORAGE TEMP., HUMIDITY	-30 ~ +85°C, 10 ~ 95% RH non-condensing					
	TEMP. COEFFICIENT	±0.03%/°C (0 ~ 50°C)					
	VIBRATION	10 ~ 500Hz, 5G 10min./1cycle, 60min. each along X, Y, Z axes					
SAFETY & EMC (Note 5 & 6)	SAFETY STANDARDS	UL62368-1, BS EN/EN62368-1, AS/NZS62368.1, EAC TP TC 004 approved; Design refer to GB 17945-2010 , GB4717					
	WITHSTAND VOLTAGE	I/P-O/P:3KVAC I/P-FG:2KVAC O/P-FG:0.5KVAC					
	ISOLATION RESISTANCE	I/P-O/P, I/P-FG, O/P-FG:100M Ohms / 500VDC / 25 °C 70% RH					
	EMC EMISSION	Parameter	Standard		Test Level / Note		
		Conducted	BS EN/EN55032 (CISPR32), EAC TP TC 020		Class A		
		Radiated	BS EN/EN55032 (CISPR32), EAC TP TC 020		Class A		
		Harmonic Current Voltage Flicker	-----		-----		
	EMC IMMUNITY	Parameter	Standard		Test Level / Note		
		ESD	BS EN/EN61000-4-2		Level 3, 8KV air ; Level 2, 6KV contact; criteria A		
		Radiated	BS EN/EN61000-4-3		Level 3, 10V/m ; criteria A		
EFT / Burst		BS EN/EN61000-4-4		Level 3, 2KV ; criteria A			
Surge		BS EN/EN61000-4-5		Level 3, 1kV/Line-Line ; 2kV/Line-FG ; criteria A			
Conducted Magnetic Field		BS EN/EN61000-4-6 BS EN/EN61000-4-8		Level 3, 10V ; criteria A Level 4, 30A/m ; criteria A			
OTHERS	MTBF	1019.6K hrs min. Telcordia SR-332 (Bellcore); 144.4K hrs min. MIL-HDBK-217F (25)					
	DIMENSION	225*124*41mm (L*W*H)					
	PACKING	1.02Kg; 12pcs/13.5Kg/0.78CUFT					

LAD-600x Series TTL Communication Function Model(Blank Version)

MODEL	LAD-600B		LAD-600C		LAD-600D		
OUTPUT	OUTPUT NUMBER	CH1	CH2	CH1	CH2	CH1	CH2
	DC VOLTAGE	27.6V	27.6V	41.5V	41.5V	55.2V	55.2V
	RATED CURRENT	18.74A	3A(Battery Charger)	11.45A	3A(Battery Charger)	7.87A	3A(Battery Charger)
	CURRENT RANGE	0 ~ 21.74A	-----	0 ~ 14.45A	-----	0 ~ 10.87A	-----
	RATED POWER	600.02W	-----	599.67W	-----	600.02W	-----
	RIPPLE & NOISE (max.) Note.2	270mVp-p	-----	360mVp-p	-----	360mVp-p	-----
	VOLTAGE ADJ. RANGE	CH1: 21.6 ~ 29V	-----	CH1: 32.4 ~ 43.5V	-----	CH1: 43.5 ~ 58V	-----
	VOLTAGE TOLERANCE Note.3	±1.0%	-----	±1.0%	-----	±1.0%	-----
	LINE REGULATION	±0.5%	-----	±0.5%	-----	±0.5%	-----
	LOAD REGULATION	±0.5%	-----	±0.5%	-----	±0.5%	-----
	SETUP, RISE TIME	2000ms, 50ms/230VAC	2000ms, 50ms/115VAC at full load				
	HOLD UP TIME (Typ.)	16ms/230VAC	12ms/115VAC at full load				
INPUT	BATTERY STATIC DISCHARGE CURRENT	<100µA					
	VOLTAGE RANGE	90 ~ 132VAC / 180 ~ 264VAC by switch		240 ~ 370VDC (Default switch at 230VAC)			
	FREQUENCY RANGE	47 ~ 63Hz					
	EFFICIENCY (Typ.)	90%		91%		91%	
	AC CURRENT (Typ.)	12A/115VAC 7.5A/230VAC					
	INRUSH CURRENT (Typ.)	COLD START 35A/115VAC 60A/230VAC					
	LEAKAGE CURRENT	<0.5mA Peak / 240VAC					
PROTECTION	OVERLOAD Note.4	CH1:105 ~ 135% CH2:90 ~ 110% Protection type : CH1 OLP, CH2 with battery: The unit will enter to UPS mode when CH1 is around 105%~120%, when total output of CH1 + CH2 reach around 125%~135% output shuts down CH1 OLP, CH2 without battery: Shut down o/p voltage, re-power on to removed CH2 : Constant current limiting; fault condition does not affect CH1 working, recovers automatically after fault condition is removed (External fuse is mandatory in series connection with battery for protection)					
	OVER VOLTAGE Note.4	CH1:31 ~ 36V		CH1:47 ~ 55V		CH1:59 ~ 69V	
	OVER TEMPERATURE Note.4	Protection type : Shut down o/p voltage, re-power on to removed					
	BATTERY REVERSE POLARITY	Protected when reverse polarity , no damage, recovers automatically after fault condition is removed					
	BATTERY CUTOFF	21.5V±0.5V		32V±0.5V		43V±0.5V	
FUNCTION	AC OK	TTL signal, High/Open : AC OK ; Low : AC Fail ; Ice : max. 30mA@ 50VDC					
	BATTERY DISCONNECT/ REVERSE POLARITY	TTL signal, High/Open : Battery disconnect/reverse polarity ; Low : Battery connect/normal ; Ice : max. 30mA@ 50VDC					
	BATTERY LOW	TTL signal, High/Open : Battery low ; Low : Battery normal ; Ice : max. 30mA@ 50VDC					
	BATTERY FULL	TTL signal, High/Open : Battery full ; Low : Battery charging ; Ice : max. 30mA@ 50VDC					
ENVIRONMENT	DISCHARGE	TTL signal, High/Open : Discharge Low ; Charge ; Ice : max. 30mA@ 50VDC					
	WORKING TEMP.	-20 ~ +60°C (Refer to "Derating Curve")					
	WORKING HUMIDITY	20 ~ 95% RH non-condensing					
	STORAGE TEMP., HUMIDITY	-30 ~ +85°C, 10 ~ 95% RH non-condensing					
SAFETY & EMC (Note 5 & 6)	TEMP. COEFFICIENT	±0.03%/°C (0 ~ 50°C)					
	VIBRATION	10 ~ 500Hz, 5G 10min./1cycle, 60min. each along X, Y, Z axes					
	SAFETY STANDARDS	UL62368-1, BS EN/EN62368-1, AS/NZS62368.1, EAC TP TC 004 approved; Design refer to GB 17945-2010					
	WITHSTAND VOLTAGE	I/P-O/P:3KVAC I/P-FG:2KVAC O/P-FG:0.5KVAC					
	ISOLATION RESISTANCE	I/P-O/P, I/P-FG, O/P-FG:100M Ohms / 500VDC / 25 °C 70% RH					
	EMC EMISSION	Parameter	Standard		Test Level / Note		
		Conducted	BS EN/EN55032 (CISPR32), EAC TP TC 020		Class A		
		Radiated	BS EN/EN55032 (CISPR32), EAC TP TC 020		Class A		
		Harmonic Current Voltage Flicker	-----		-----		
	EMC IMMUNITY	Parameter	Standard		Test Level / Note		
ESD		BS EN/EN61000-4-2		Level 3, 8KV air ; Level 2, 6KV contact; criteria A			
Radiated		BS EN/EN61000-4-3		Level 3, 10V/m ; criteria A			
EFT / Burst		BS EN/EN61000-4-4		Level 3, 2KV ; criteria A			
Surge		BS EN/EN61000-4-5		Level 3, 1kV/Line-Line ; 2kV/Line-FG ; criteria A			
Conducted Magnetic Field		BS EN/EN61000-4-6 BS EN/EN61000-4-8		Level 3, 10V ; criteria A Level 4, 30A/m ; criteria A			
OTHERS	MTBF	1154.4K hrs min. Telcordia SR-332 (Bellcore); 169.9K hrs min. MIL-HDBK-217F (25)					
	DIMENSION	225*124*41mm (L*W*H)					
	PACKING	1.02Kg; 12pcs/13.5Kg/0.78CUFT					

2.4 Safety overview



2.5 Derating curve & static characteristic curve

2.5.1 Derating curve

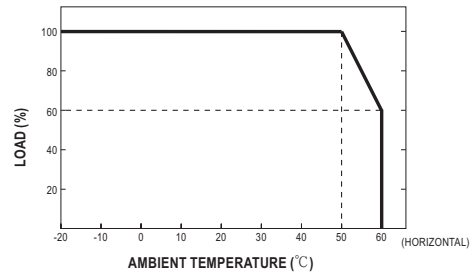

2.5.2 Static characteristic curve

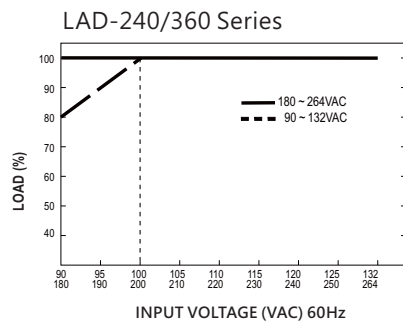
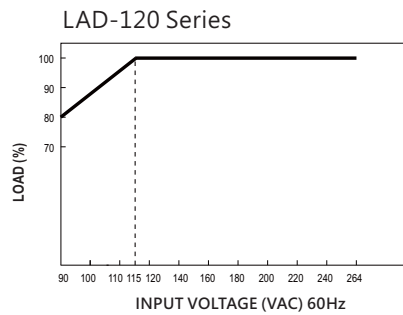

LAD-600 Series

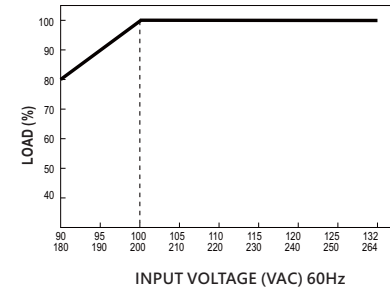

2.6 Mechanical specification

LAD-120 Series

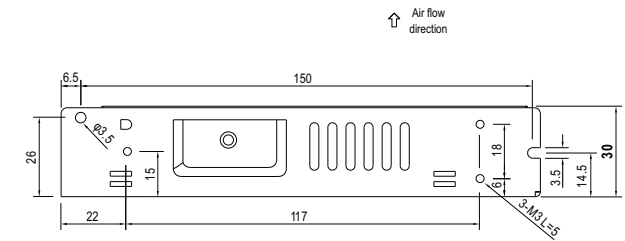
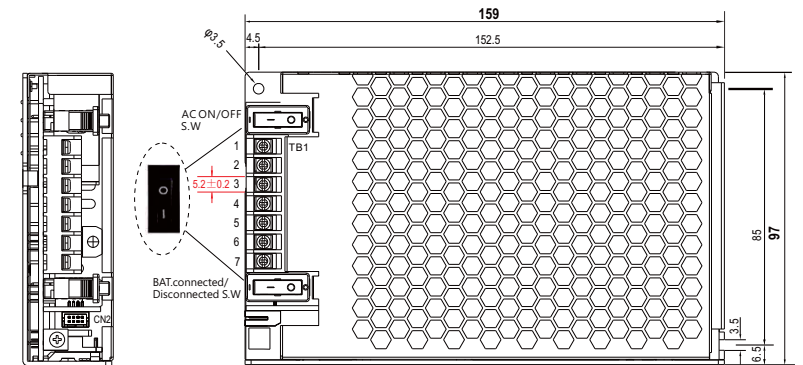

LAD-240/360 Series

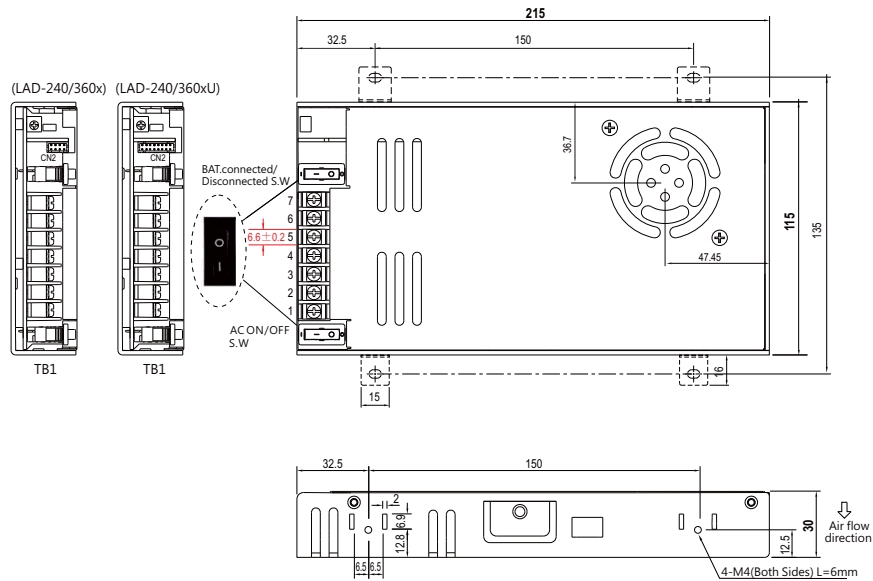

LAD-600 Series

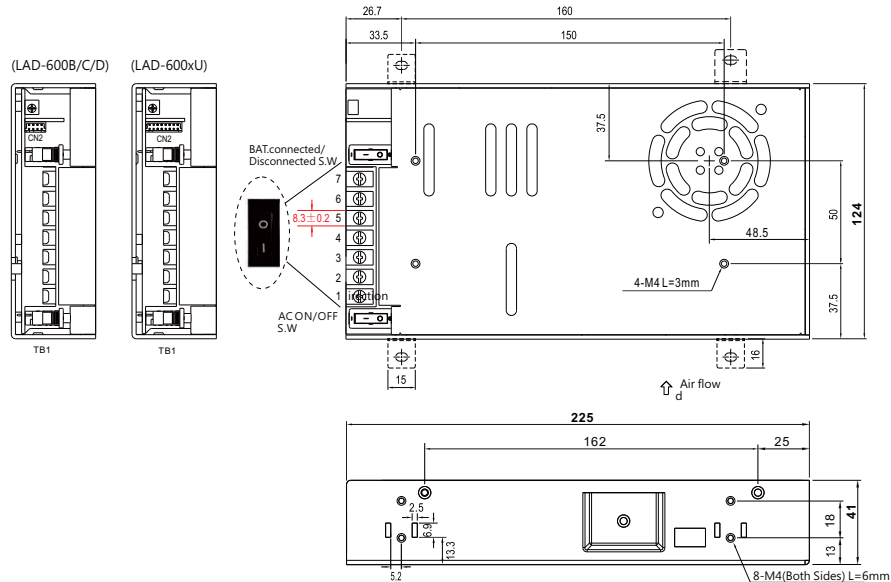

3. Installation Introduction

3.1 Installation requirements

- Before any installation or maintenance work, please disconnect your system from the utility. Ensure that it can't be re-connected inadvertently!
- Keep enough insulation distance between mounting screws and internal components of power supplies. Please refer to case drawing on specifications to receive the maximum length of mounting screw.
- Mounting orientations other than standard orientation or operate under high ambient temperature may increase the internal component temperature and will require a de-rating in output current. Please refer to Chapter 2.5 to receive the optimum mounting position and information about the de-rating curve.
- Fans and ventilation holes must be kept free from any obstructions. Also a 10-15 cm clearance must be kept when the adjacent device is a heat source.

3.2 Case mounting holes torque recommendations:

Model	Screw Specification(Metric screws)	Assembly Recommended Torque(kgf-cm)
LAD-120	M3	8.8±20%
LAD-240/360/600	M4	20.4±20%

If the recommended torque is considered too small, it is recommended to use a drop-resistant screw to increase the torsion that can be tolerated.

3.3 Wiring use

For input and output terminal block screw specifications, recommended torque and wire diameter, please refer to the table below.

Terminals Series	Input / output terminal block		
	Screw Specification	Suggested Torque	Wire
LAD-120	M2.5	4.08kgf-cm(3.54Lb-in)	18-12AWG
LAD-240/360	M3	5.11kgf-cm(3.54Lb-in)	16-12AWG
LAD-600	M4	12.22kgf-cm(3.54Lb-in)	14-10AWG

Note: Please refer to chapter 2.6 for the single terminal spacing of the terminal block.

3.4 Installation steps

3.4.1 Please make sure the main power and backup power switches are OFF first, then connect AC input cables, DC output cables, battery charging cables to the terminal blocks.

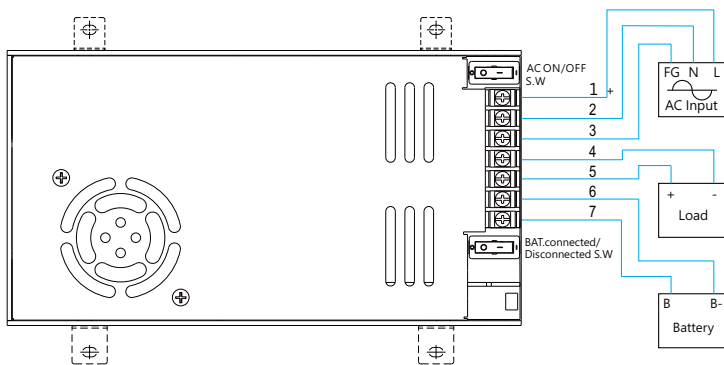

3.4.2 Make sure all cables are well connected, then feeds the AC power to the supply, and turn the main power and backup power switches to the ON position.

3.5 Serial and parallel connection of battery

- Serial connection: When connect 2 batteries in series, it doubles the output voltage, but the total capacity remains.
EX: 2pcs of 12V 100AH in series, become a 24V 100AH battery.

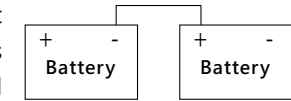

- Parallel connection: When 2 batteries connected in Parallel, output voltage remains, but the total capacity becomes doubled.
EX: 2pcs of 12V 100AH connect in parallel, become a 12V 200AH battery.

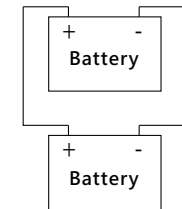

4. User Interface Panel

4.1 Panel Description

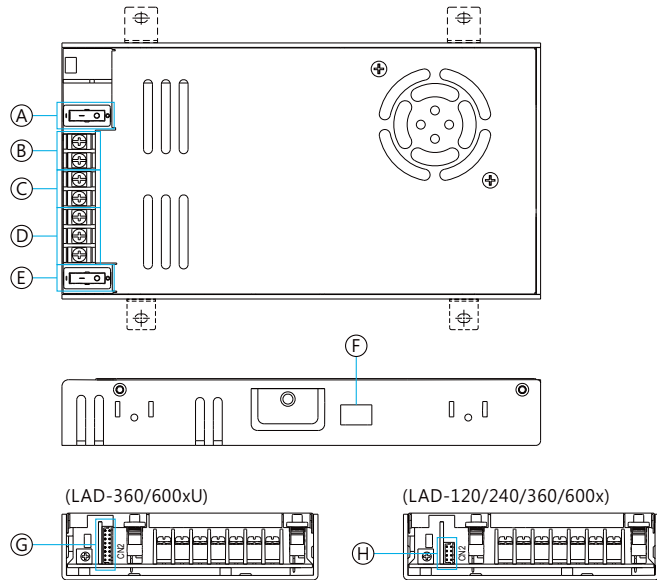

- (A) BAT.connected/Disconnected S.W**
It is used to connect the **(B)** battery charging terminal and the LAD internal circuit. When it is turned OFF, the internal circuit and the external connection are cut off.
- (B) BAT-&BAT+**
To connect to external batteries.
- (C) DC OUTPUT-&DC OUTPUT+**
To connect to applications.
- (D) AC/L&AC/N**
To connect to AC main supply.
- (E) AC ON/OFF S.W**
It is used to connect the **(D)** AC input terminals and the LAD internal circuit. When it is turned OFF, the internal circuit and the external connection are cut off.
- (F) 115VAC/230VAC S.W**
Selected based on AC main supply.

- (G) Communication function terminal contacts**
It is used to control and status monitoring, etc. For details, please refer to Chapter 4.2.1.
- (H) TTL function terminal contacts**
It is used to control and status monitoring, etc. For details, please refer to Chapter 4.2.2.

4.2 Pin Assignment

4.2.1 Connector Pin No. Assignment(CN2)(LAD-360/600xU)

The suitable mating terminal for CN2 is TKP DH2I-2*8 or equivalent.

Pin number	Function	Description	Connector	
12	Short: force start	Force the LAD to operate in UPS mode		
	Open: normal work			
34	Short: coordinated control	Remote UPS control		
	Open: normal work			
5 6	Short: lithium battery	Battery type selection		
	Open: lead-acid battery			
7 8	BU	Open: fire alarm mode		Evacuation/fire alarm selection
		Short: evacuation mode		
	CU/DU	Open: evacuation mode		
		Short: firealarm mode		
9	BAT1	Battery inspection connection		
10	BAT2			
11	NC			
12	BAT3			
13	UART_RX	UART communication data line interface		
14	UART_TX			
16	3.3V	+3.3V(ref) for testing use only; can't supply power over 1mA for a long time		

4.2.2 Connector Pin No. Assignment(CN2)(LAD-120/240/360/600x)

The suitable mating terminal for CN2 is TKP DH2I-2*8 or equivalent.

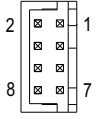
Pin No.	Assignment(TTL Signal)	Connector	Connector	Terminal
1	ACOK		TKP DH2 or equivalent	TKP or equivalent
2	Battery disconnect/ reverse polarity			
3	Battery low			
4	GND			
5	Battery full			
6	Discharge			
7,8	Open : normal Short : forced start			

5.Function Description

The LAD series equip multiple functions, including four main functions such as DC voltage supplying power to the load, charging the battery, DC-UPS backup, and communication monitoring interface. It also has auxiliary functions such as TTL signal (AC OK, battery unconnected/reverse connection, battery undervoltage/full), linkage control, battery selection, buzzer alarm, battery detection, forced start of battery power supply, etc.

5.1 DC-UPS function

- LAD-120/240/360/600x(blank version)

When the AC main supply is abnormal, the LAD switches to the battery backup (UPS mode).

- LAD-240/360/600xU(UART version)

When the DIP switch sets to 115VAC and the AC voltage drops to 75VAC, the LAD switches to battery backup.

When the DIP switch is turned to 230VAC and the AC voltage drops to 165VAC, the power supply is switched to battery backup.

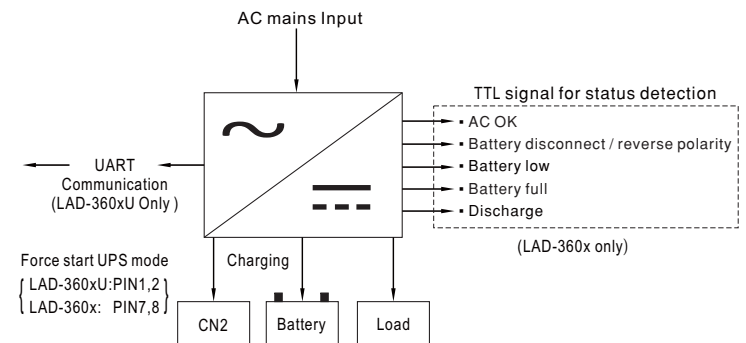

5.2 UART Communication Function(U version only)

The LAD various fault signals, power supply working status, single battery voltage, main voltage, output voltage and output current to the controller through the UART, and changes the power supply working status according to the controller instructions. For details. please refer to the 5.4.

5.2.1 Forced Start & Remote UPS Control(U version only)

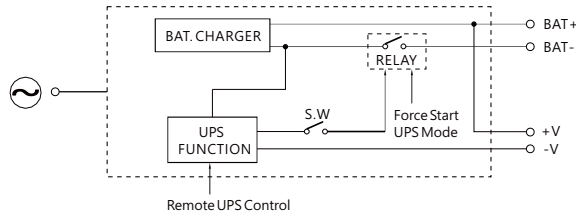

Both "forced start" and "remote UPS control" can force the power supply to operate in battery back(UPS) mode . Both can be used separately or simultaneously. When implemented at the same time, the priority of "Forced Start" is higher than "remote UPS Control".

5.2.1.1 Force start UPS mode:

According to fire safety regulation, UPS power supply must equip with force start UPS function. In case of emergency, maintenance or testing, Operators can active the UPS mode by shorting PIN1 and PIN2 of LAD-360/600xU to ensure battery power supply to the loads. When operating under UPS mode, the BAT. UVP alarm is still active, but the BAT. UVP protection is invalid, therefore, the battery will be fully discharged until system shuts down.

PIN1&2	Status
Short	Forced start
Open	Normal



● Description of force start UPS mode

- (1) In the case of no AC input power supply, when the backup power switch is OFF, PIN 1 and 2 need to be short-circuited all the time, to force the UPS function to start, and keep the battery powered; when PIN 1, 2 is open, the battery power supply is disconnected.
- (2) In the case of no AC input power supply, when the backup power switch is ON, PIN 1 and 2 need to be short-circuited , to force the UPS function to start, powered by battery. When PIN1, 2 are shorted and disconnected after a few seconds, the battery power is still maintained.

5.2.1.2 Remote UPS mode

Remote UPS mode:

According to fire safety regulation, UPS power supply must equip with remote UPS function. So the power supply unit can be linked to the fire alarm system, user's system will be able to detect the status of PIN3 and PIN4 LAD-360xU with UART communication. When PIN 3 and PIN 4 is shorted, the power supply will enter remote UPS mode. Therefore, the UPS mode will be active and the status signal will also send to the fire alarm system for indication. Personal or the system can use the signal as trigger threshold for other alarm systems to decide when and how to enter the emergency sequence. Under this condition, BAT. UVP alarm and protection are still active.

PIN3&4	Status
Short	Remote UPS control
Open	Normal



5.2.2 Charging curves of different batteries

Two different charging curves can be determined through the short circuit and open circuit of pin 5&6.

Pin 5 & 6	Battery Type
Short	Li-ion batteries
Open	Lead-acid (Pb) batteries



◎ Charging curve

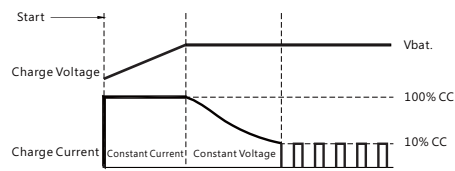

◎ Apply to Lead-acid batteries

◎ Charging curve

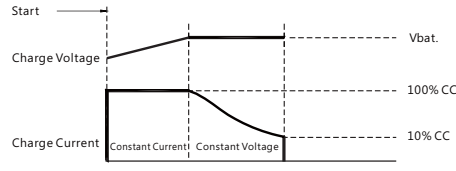

◎ Apply to Li-ion batteries

NOTE: In security applications, lead-acid batteries are generally used for floating charging. It is recommended that the charging voltage of the LAD should not exceed the floating charging voltage of the battery to ensure that the battery does not under long-term use.

The way to connect the battery test point:

※LAD-360/600BU

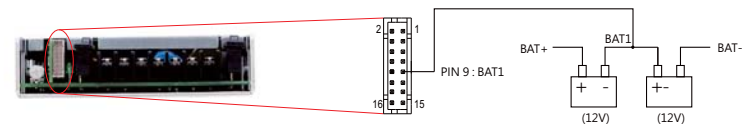

※LAD-360/600CU

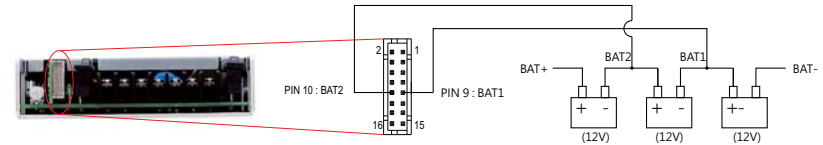

※LAD-360/600DU

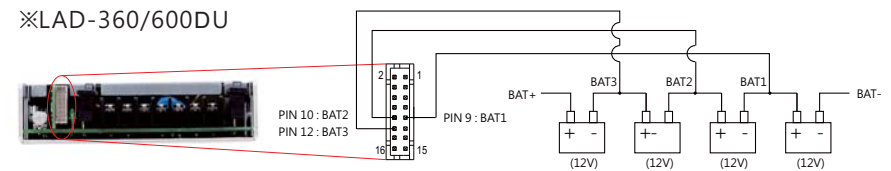

5.2.3 Buzzer mode selection

Fire alarm system : When the battery is under voltage, the buzzer will alarm.
Evacuation system: When the battery is under voltage, the battery is missing, the battery is reversely connected, and the output is overloaded, the buzzer will alarm.

Pin 7 & 8		Status
BU	Open	Fire alarm system
	Short	Evacuation system
CU/DU	Short	Fire alarm system
	Open	Evacuation system



5.2.4 Battery Inspection

Read each battery voltage through UART communication, the buzzer will alarm when the battery voltage is abnormal, please refer to Chapter 5.4.1.7 & 5.4.2.5.

5.2.5 UART Communication Interface(U version only)

Communication provides functions such as control, setting, and monitoring.

The parameters include the backup power switch, battery undervoltage point ,etc.



5.3 Function signals by TTL (Blank version)

- TTL Signal is sent out through pins from CN2.
- External voltage source is required for the TTL signal. The maximum voltage is 50VDC and the maximum sink current is 30mA.

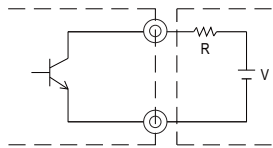

External voltage and resistor
(The max. sink current is 30mA at 50VDC)

5.3.1 AC OK TTL signal : detection of AC status

- LAD-120: When the input voltage is abnormal, it sends out the AC fault signal.
- LAD-240/360/600xU: AC input voltage can be selected by 110V/230V DIP switch.
115VAC input: When the input voltage is <75VAC, the AC fault signal will be sent, and the main voltage will be restored when the input voltage is greater than 87VAC.
230VAC input: When the input voltage is <165VAC, the AC fault signal will be sent, and the main voltage will be restored when the input voltage is greater than 175VAC.

Between pin 1 and pin 4	Description
Low (0.3V max. at 30mA)	The signal is "Low" when the AC input is normal
High or open (External applied voltage 50V max.)	The signal turns to be "High" when the AC input is abnormal



5.3.2 Battery disconnected/reverse TTL signal: battery detection status

When the battery is not connected or reversely connected, the state is high/low level, and the battery status can be known by detecting this signal.

Between pin 2 and pin 4	Description
Low (0.3V max. at 30mA)	The signal is "Low" when the battery is not connected or inversely connected
High or open (External applied voltage 50V max.)	The signal turns to be "High" when the battery is connected or normal

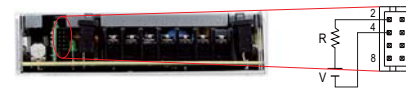

5.3.3 Battery Low: Battery low detection

Undervoltage protection point:

- A Series: $10V \pm 0.5$
- B Series: $21.5V \pm 0.5$
- C Series: $32V \pm 0.5$
- D Series: $43V \pm 0.5$

Between pin 3 and pin 4	Description
Low (0.3V max. at 30mA)	The signal is "Low" when the battery is under voltage protected
High or open (External applied voltage 50V max.)	The signal turns to be "High" when the battery is normal



5.3.4 Battery Full : Battery full detection

Between pin 4 and pin 5	Description
Low (0.3V max. at 30mA)	The signal is "Low" when the charging current <math> < 10\% \pm 5\% </math> rated current
High or open (External applied voltage 50V max.)	The signal turns to be "High" when the charging current >math> > 11\% \pm 5\% </math> rated current



5.3.5 Discharge: Discharge detection

It is used to check whether the system is powered by AC power supply or backup power supply.

Note: When the backup power is working, the load current of the CH1 channel must be greater than 15% of the rated current for the TTL signal to act.

Between pin 4 and pin 6	Description
Low (0.3V max. at 30mA)	The signal is "Low" when the power supply is discharging
High or open (External applied voltage 50V max.)	The signal is "High" when the main power is working

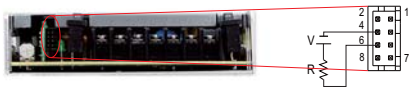

5.3.6 Forced Start: Forced start UPS mode

According to fire safety regulation, UPS power supply must equip with force start UPS function. In case of emergency, maintenance or testing, operators can active the UPS mode by shorting PIN7 and PIN8 of LAD series. To ensure battery power supply to the loads. When operating under UPS mode, the BAT.UVP alarm is still active, but the BAT.UVP Protection is invalid. Therefore, the battery will be fully discharged until system shuts down.

Pin 7 & 8	Status
Short	Forced start UPS mode
Open	Normal



5.4 Communication monitoring function

5.4.1 UART communication

LAD-360/600U series products and external controller (Controller)/PC software can be transmitted through UART. The internal data of a single LAD-360/600U can be set and read through communication, and multiple parallel connections cannot be used in the configuration.

5.4.1.1 UART specification

Protocol adopts UART interface

This device adopts UART two-wire TX/RX Bus transmission mode. Except for Error Check (CRC-8) data, all word data must conform to the principle of High byte first transmission.

The communication experiment layer is set as follows:

Control	Setting
Baud rate	9600
Data bits	8
stop bit	1
check bit	none
Serial flow control	none

5.4.1.2 Communication timing

Minimum request period(Controller/PC to LAD):20mSec.

Maximum response time(LAD to Controller/PC to LAD): 5mSec.

Minimum packet interval time(Controller/PC to LAD): 5mSec.

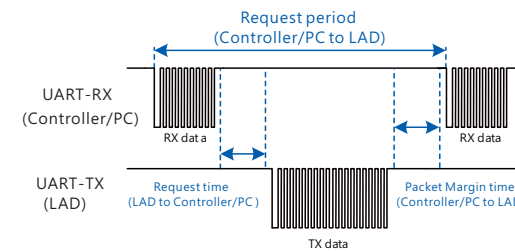

5.4.1.3 The basic packet structure of the UART communication protocol

UART communication consists of R/W byte, Data Length, Data address bytes, Data bytes, Error check.

(1) LAD transmission frame (LAD to Controller/PC ; Controller/PC to LAD)

R/W byte	Data Length	Data address bytes	Data bytes	Error check (CRC-8)
----------	-------------	--------------------	------------	-----------------------

(2) Definition description

Name	Narrate	Range
R/W byte	R/W decision bit	1. Read data (0x55) 2. Write data (0xAA)
Data Length	The length of the data after the R/W bit is determined	1 byte
Data address bytes	The address of the data to be transmitted	2 bytes
Data bytes	The content of the data to be transmitted	Calculated by actual bytes
CRC-8	Transmits a data CRC-8 error code (Contains R/W byte ~ Data bytes).	1 byte

Note : Cyclic Recundancy Check (CRC) is a channel coding technology that generates a short fixed-bit check code based on data such as network packets or computer files, which is mainly used to detect or verify errors that may occur after data transmission or saving, and uses the principle of division and remainder to detect errors.

LAD models currently use CRC-8 as a means of error detection, which is based on the following polynomial:

$$X^8 + X^2 + X + 1$$

Specific numerical calculations can be calculated using the checksum calculation tool from MEANWELL, which can be consulted with local business or technical service engineers.

5.4.1.4 Definition of data types

The data transmission patterns of this agreement are defined as follows:

Data type	Narrate	Bytes	Range
U1	Unsigned char	1	0 ~ 255
U2	unsigned integer	2	0 ~ 65535
S1	signed char	1	-128 ~ 127
S2	Signed integer	2	-32768 ~ 32767

5.4.1.5 Scratchpad Address Data Description

Controller/PC to LAD datasheet

R/W byte	Data address bytes	The data name	narrate	Numeric range	Data type	unit
0x55	0x0010	LAD status	LAD status flag read instruction	-	U1	-
	0x0020	Principal electrical voltage	Input voltage read instructions	0 ~ 65535	U2	-
	0x0030	Load current	Load current read instruction	0 ~ 65535	U2	-
	0x0040	Battery voltage	The total voltage of the battery series reads the instruction	0 ~ 65535	U2	-
	0x0050	Single cell battery voltage	Single-cell battery voltage read instruction	0 ~ 65535	U2	-
	0x0060	Battery undervoltage protection point	Battery UDP point read instructions	0 ~ 65535	U2	-
0xAA	0x0010	Standby excision instructions	Backup removal control	-	U1	-
	0x0020	Battery undervoltage protection point	Battery UTP point setting	0 ~ 65535	U2	0.01V
	0x0030	Buzzer control	Buzzer off control	-	U1	-
	0x0040	Standby enable command	The main standby power is normal when the communication enables the power backup control command		U1	-

Note: (1) The 0x0020 instruction written is invalid when the force startup state is forced

(2) The written 0x0050 instructions, if connected according to the battery detection point connection, in order to detect the battery voltage normally, otherwise FF will be reported

(3) Write command without memory function, restore factory settings after shutdown

LAD to Controller/PC data sheet

R/W byte	Data address bytes	The data name	narrate	Numeric range	The length of the data	unit
0x55	0x0010	LAD status	LAD status flag	Instructions for transmitting data	4 bytes	-
	0x0020	Principal electrical voltage	Input voltage	0~65535	2 bytes	0.1V
	0x0030	Load current	Load current	0~65535	2 bytes	0.01A
	0x0040	Battery voltage	Total battery series voltage	0~65536	2 bytes	0.01V
	0x0050	Single cell battery voltage	Single cell battery voltage	0~65536	8 bytes	0.01V
	0x0060	Battery undervoltage protection point	Battery ULP point read	0~65536	2 bytes	0.0

5.4.1.6 Instructions for Transmitting Data:

Data is transferred in packets, reducing transfer time and avoiding excessive data processing.

	The user reads and writes the set bit	Data address range	Address used	Note
Controller/PC to LAD	0x55 · 0xAA	0x0001~0xFFFF	0x0010~0x0060	1. 0x55 is used for reading LAD parameters 2. 0xAA for writing to the LAD parameter configuration
LAD to Controller/PC	0x55	0x0001~0xFFFF	0x0010~0x0060	1. Transmit the required packets according to the user's sending address

5.4.1.7 LAD_STATUS defined as follows:

The LAD_STATUS consists of two parts, LAD_STATUS_H and LAD_STATUS_L, with a total of 4 bytes, LAD_STATUS_H at the high level and LAD_STATUS_L at the low level.

LAD_STATUS_H:

	Bit7	Bit6	Bit5	Bit4	Bit3	Bit2	Bit1	Bit0
High byte	Reserved	Reserved	Reserved	Reserved	Reserved	Reserved	Reserved	Reserved
Low byte	Reserved	Reserved	Reserved	Reserved	Reserved	Reserved	Reserved	BAT_SW_OFF

Low byte :

Bit 0 BAT_SW_OFF: Standby switch status display

0 = The standby switch is normal

1 = Standby switch disconnected

Bit 1 – Bit 7: Currently unused, reserved (default is 0, displayed status is not supported as 0)

High byte:

Bit 0 - Bit 7 Reserved: Currently unused, reserved (default is 0, displayed status is not supported as 0)

LAD_STATUS_L

	Bit7	Bit6	Bit5	Bit4	Bit3	Bit2	Bit1	Bit0
High byte	Force_Status	BAT_REV	BAT_CHGILL	BAT_CHGFULL	BAT_ERROR_4	BAT_ERROR_3	BAT_ERROR_2	BAT_ERROR_1
Low byte	BAT_NO_Balance	BAT_OVP	Link_Ctrl	LAD Power Supply	BAT_UVP	DISCHARGE_OLP	BAT_NC	AC_OK

Low byte:

Bit 0 AC_OK: AC input status

0=AC input exception

1=AC input is normal

Bit 1 BAT_NC: Power-up status

0 = Standby access is normal

1 = Abnormal power backup access

Bit 2 DISCHARGE_OLP: The OLP state of the main discharge

0 = The main discharge is normal

1 = Main discharge overload

Bit 3 BAT_UVP: Power-up ULP protection status

0 = No backup UTP protection

1 = Power backup UPP protection has occurred

Bit 4 LAD Power Supply: System power supply status

0 = Main power supply status

1 = Standby power supply status

Bit 5 Link_Ctrl: Linkage control status indication

0 = Non-linkage control state

1 = in the linkage control state

Bit 6 BAT_OVP: Standby OVP protection status

0 = Non-backup OVP status

1 = in standby OVP state

Bit 7 BAT_NO_Balance: Battery balanced

0 = Battery balanced state

1 = Battery unbalanced state

High byte:

Bit 0 BAT_ERROR_1: BAT1 battery status

0 = BAT1 battery is normal

1 = BAT1 battery abnormality

Bit 1 BAT_ERROR_2: BAT2 battery status

0 = BAT2 battery is normal

1 = BAT2 battery abnormality

Bit 2 BAT_ERROR_3: BAT3 battery status

0 = BAT3 battery is normal

1 = BAT3 battery abnormality

Bit 3 BAT_ERROR_4: BAT4 battery status

0 = BAT4 battery is normal

1 = BAT4 battery abnormality

Bit 4 BAT_CHGFULL: Battery full

0 = Battery is not full

1 = Battery full

Bit 5 BAT_CHGING: Battery charged state

0 = Battery is not charged

1 = Battery charged state

Bit 6 BAT_REV: Reverse battery state

0 = Battery is not reversed

1 = Reverse battery state

Bit 7 Force_Status: Strong-on state

0 = Non-force start state

1 = Force start state

5.4.2 Examples of Communications

The following provides an example of reading and writing to the UART communication protocol

Note: 5.4.2.1~5.4.2.6 provides an example for reading instructions, 5.4.2.7~5.4.2.9 is a write instruction to modify the power supply and battery state, and write no memory function, and restore the factory settings after shutdown

5.4.2.1 LAD_STATUS

Brief description: read the LED status

For example: to read the current status of THE LED-360DU

Request:

R/W byte	Data Length	Data address bytes	Data bytes	CRC-8
0x55	0x03	0x00 10		0x7F

0x55: R/W byte, R/W decision bit, for reading instructions are 0x55

0x03: Data Length, the length of the data after the R/W decision bit,

In this instruction 0x00 10, 0x7F occupy a total of 3 bytes, so it is 0x03

0x00 10: Data address bytes, the address of the data to be transmitted, 0x00 10 is the LAD_STATUS address

Data bytes: The data content to be transmitted, the field for the read instruction is empty

0x7F: Transmit data CRC-8 error detection code (including R/W byte ~ Data bytes), refer to 5.4.1.3 for the description of CRC-8, for which the instruction is 0x7F

Request:

R/W byte	Data Length	Data address bytes	Data bytes	CRC-8
0x55	0x07	0x00 10	0x00 01 17 81	0x4C

0x55: R/W byte, R/W decision bit, for reading instructions are 0x55

0x07: Data Length, data length after R/W bit,

In this instruction 0x00 10, 0x00 01 17 81 and 0x4C occupy a total of 7 bytes, so it is 0x07

00 10: Data address bytes, the data address transmitted by LAD, 0x00

10 is the LAD_STATUS address

00 01 17 81: Data bytes, data content transmitted by LAD, this is the actual reading value of the

00 01 is LAD_STATUS_H, converted to binary is:

00000000	00000001
high byte	low byte

17 81 is LAD_STATUS_L, converted to binary is:

00010111	1000001
High byte	low byte

The current STATUS of LAD-360DU can be derived from the definition of the LAD_STATUS as follows:

LAD_STATUS_H: only the bit 0 of low byte has practical significance, which is 1 in this instruction, which means that the standby switch is disconnected at this time

LAD_STATUS_L: the status is as follows (gray background content).

		Bit 7	Bit 6	Bit 5	Bit 4	Bit 3	Bit 2	Bit 1	Bit 0
		Strong start state	Battery reverse connection status	Battery charge status	Battery full	BAT4 battery status	BAT2 battery status	BAT3 battery status	BAT1 battery status
High byte	1	Strong start state	Battery reverse connection status	Battery charge status	Battery full	BAT4 battery status	BAT2 battery status	BAT3 battery status	BAT1 battery status
	0	Non-forced state	The battery is not reversed	The battery is not charged	The battery is not full	The BAT4 battery is normal	The BAT3 battery is normal	The BAT2 battery is normal	The BAT1 battery is normal
		Battery balanced state	Standby OVP protection status	Linkage control status display	System power supply status	Standby UTP protection status	Main discharge OLP status	Standby status	AC OK
Low byte	1	Non-cell balanced state	It is in the backup OVP protection state	In the linkage control state	Standby power supply status	A backup ULP protection state has occurred	The main road discharge is overloaded	The power backup access is abnormal	AC input is ok
	0	Battery balanced state	Non-backup OVP protection status	Non-linkage control state	The main power supply status	No backup UTP protection	The main circuit discharge is normal	The backup power is connected normally	AC input exception

0x4C: Transmit data CRC-8 error code, refer to 5.4.1.3 for CRC-8

The CRC-8 error detection code for the LAD response is calculated by the LAD's own MCU

5.4.2.2 Main electrical voltage

Brief description: Input voltage read instructions

For example: to read the LAD-360DU input voltage

Request:

R/W byte	Data Length	Data address bytes	Data bytes	CRC-8
0x55	0x03	0x00 20		0xEF

0x55: R/W byte, R/W decision bit, for reading instructions are 0x55

0x03: Data Length, the length of the data after the R/W decision bit

In this instruction 0x00 20, 0xEF occupy a total of 3 bytes, so it is 0x03

0x00 20: Data address bytes, the data address to be transmitted, 0x00 20 is the main voltage address

0xEF: Transmit data CRC-8 error detection code (including R/W byte ~ Data bytes), refer to the instructions on CRC-8 in 5.4.1.3, for which the instruction is 0xEF

Response:

R/W byte	Data Length	Data address bytes	Data bytes	CRC-8
0x55	0x05	0x00 20	0x08 FE	0x97

0x55: R/W byte, R/W decision bit, for reading instructions are 0x55

0x05: Data Length, the length of the data after the R/W decision bit

In this instruction 0x00 30, 0x08 FE, 0x35 occupy a total of 5 bytes, so it is 0x05

0x00 20: Data address bytes, data address transmitted by LAD, 0x00 20 is the main voltage address

0x08 FE: Data bytes, the data content transmitted by LAD, which is the actual reading value of the main electrical voltage

0x08 FE corresponds to the decimal number of 2302, check the 5.4.1.5 table, you can get that the corresponding unit of this command is 0.1V, that is, the input voltage at this time is $2302 * 0.1V = 230.2V$

0x97: Transmit data CRC-8 error code, refer to the instructions on CRC-8 in 5.4.1.3

The CRC-8 error detection code for the LAD response is calculated by the LAD's own MCU

5.4.2.3 Load current

Brief description: Load current read instruction

For example: to read the LED-360DU load current

Request:

R/W byte	Data Length	Data address bytes	Data bytes	CRC-8
0x55	0x03	0x00 30		0x9F

0x55: R/W byte, R/W decision bit, for reading instructions are 0x55

0x03: Data Length, the length of the data after the R/W decision bit

In this instruction 0x00 30, 0x9F occupy a total of 3 bytes, so it is 0x03

0x00 30: Data address bytes, the address of the data to be transmitted, 0x00 30 is the load current address

0x9F: Transmit the data CRC-8 error detection code, refer to the instructions on CRC-8 in 5.4.1.3, for which the instruction is 0x9F

Response:

R/W byte	Data Length	Data address bytes	Data bytes	CRC-8
0x55	0x05	0x00 30	0x02 91	0xBD

5.4.2.4 Battery voltage

Brief description: Battery voltage read instructions

For example: to read the battery voltage to which the LAD-360DU is connected

Request:

R/W byte	Data Length	Data address bytes	Data bytes	CRC-8
0x55	0x03	0x00 40		0xC8

0x55: R/W byte, R/W decision bit, for reading instructions are 0x55

0x03: Data Length, the length of the data after the R/W decision bit

In this instruction 0x00 40, 0xC8 occupy a total of 3 bytes, so it is 0x03

0x00 40: Data address bytes, the address of the data to be transmitted, 0x00 40 is the battery voltage address

0xC8: Transmit data CRC-8 error detection code, refer to the instructions on CRC-8 in 5.4.1.3, for which the instruction is 0xC8

Response:

R/W byte	Data Length	Data address bytes	Data bytes	CRC-8
0x55	0x05	0x00 40	0x12 B6	0x33

0x55: R/W byte, R/W decision bit, for reading instructions are 0x55

0x05: Data Length, the length of the data after the R/W decision bit

In this instruction 0x00 40, 0x12 B6, 0x33 occupy a total of 5 bytes, so it is 0x05

0x00 40: Data address bytes, the data address transmitted by LAD, 0x00 40 is the battery voltage address

0x12 B6: Data bytes, lad transmitted data content, this is the actual reading value of the battery voltage

0x12 B6 corresponds to the decimal number of 4790, check the 5.4.1.5 table, you can get that the corresponding unit of this command is 0.01V, that is, the battery voltage at this time is $4790 * 0.01V = 47.9V$

0x33: Transmit data CRC-8 error detection code, refer to the instructions on CRC-8 in 5.4.1.3

The CRC-8 error detection code for the LAD response is calculated by the LAD's own MCU

5.4.2.5 Single cell battery voltage

Brief description: Battery voltage read instructions

For example: to read the voltage of a single cell connected to the LAD-360DU

Request:

R/W byte	Data Length	Data address bytes	Data bytes	CRC-8
0x55	0x03	0x00 50		0xB8

0x55: R/W byte, R/W decision bit, for reading instructions are 0x55

0x03: Data Length, the length of the data after the R/W decision bit

In this instruction 0x00 50, 0xB8 occupy a total of 3 bytes, so it is 3 bytes

0x00 50: Data address bytes, the data address to be transmitted, 0x00

50 is the single-cell battery voltage address

0xB8: Transmit data CRC-8 error code, refer to the description of CRC-8 in 5.4.1.3, for which the instruction is 0xB8

Response:

R/W byte	Data Length	Data address bytes	Data bytes	CRC-8
0x55	0x11	0x00 50	0x04 F0 04 F2 05 0C 05 10	0xAA

0x55: R/W byte, R/W decision bit, for reading instructions are 0x55

0x11: Data Length, the length of the data after the R/W decision bit

0x00 50, 0x04 F0 04 F2 05 0C 05 10, 0xAA occupy a total of 11 bytes, so it is 0x11

0x00 50: The data address transmitted by LAD, 0x00 50 is the single-cell battery voltage address

0x04 F0 04 F2 05 0C 05 05 10: Data bytes, lad transmitted data content, this is the actual reading value of a single cell voltage, occupying 8 bytes (each battery occupies 2 bytes, from left to right is battery 1 to 4).

Convert to decimal:

04 F0 : 1264

04 F2 : 1266

05 0C : 1292

05 10 : 1296

Check the table 5.4.1.5, and the corresponding unit of this command is 0.01V, that is, the voltage of the four batteries is 12.64V, 12.66V, 12.92V, and 12.96V, respectively

0xAA: Transmit data CRC-8 error detection code, refer to the description of CRC-8 in 5.4.1.3

The CRC-8 error detection code for the LAD response is calculated by the LAD's own MCU

5.4.2.6 Battery undervoltage protection points

Brief description: Battery undervoltage protection point read instructions

For example: to read the battery voltage protection point of the LAD-360DU

Request:

R/W byte	Data Length	Data address bytes	Data bytes	CRC-8
0x55	0x03	0x00 60		0x28

0x55: R/W byte, R/W decision bit, for reading instructions are 0x55

0x03: Data Length, the length of the data after the R/W decision bit

0x00 60, 0x28 occupies a total of 3 bytes, so it is 0x03

0x00 60: Data address bytes, the data address to be transmitted, 0x00 60

is the address of the battery undervoltage protection point

0x28: Transmit data CRC-8 error detection code, refer to the instructions on CRC-8 in 5.4.1.3, for which the instruction is 0x28

Response:

R/W byte	Data Length	Data address bytes	Data bytes	CRC-8
0x55	0x05	0x00 60	0x0E E8	0x0D

0x55: R/W byte, R/W decision bit, for reading instructions are 0x55

0x05: Data Length, the length of the data after the R/W decision bit

0x00 60, 0x0E E8, 0x0D occupy a total of 5 bytes, so it is 0x05

0x00 60: Data address bytes, the data address transmitted by LAD, 0x00 60

is the address of the battery undervoltage protection point

0x0E E8: Data bytes, lad transmitted data content, this is the actual reading value of the battery undervoltage protection point 0x0E E8 corresponds to the decimal number of 3821, check the 5.4.1.5 table, you can get the corresponding unit of this command is 0.01V, that is, the battery undervoltage protection point at this time is $3821 * 0.01V = 38.21V$

0x0D: Transmit data CRC-8 error detection code, refer to the description of CRC-8 in 5.4.1.3

The CRC-8 error detection code for the LAD response is calculated by the LAD's own MCU

5.4.2.7 Backup removal control

Brief description: Backup removal control, which is invalid when forced to start

For example, turn off the standby power supply function of the LAD-360DU

Request:

R/W byte	Data Length	Data address bytes	Data bytes	CRC-8
0xAA	0x04	0x00 10	0x01	0x26

0xAA: R/W byte, R/W decision bit, for write instructions are 0xAA

0x04: Data Length, the length of the data after the R/W bit

0x00 10, 0x01, and 0x26 occupy a total of 4 bytes, so it is 0x04

0x00 10: Data address bytes, the data address to be transmitted, 0x00 10 is the backup cut control address

0x01: Data bytes, the content of the data to be transmitted, 0x01 represents the shutdown of the backup power supply function

0x26: Transmit the data CRC-8 error detection code, refer to the instructions on CRC-8 in 5.4.1.3, for which the instruction is 0x26

5.4.2.8 Battery undervoltage protection point

Brief description: Set the undervoltage protection point of the battery

For example, the undervoltage protection point of the LAD-360DU is set to 43.2V

Request:

R/W byte	Data Length	Data address bytes	Data bytes	CRC-8
0xAA	0x05	0x00 20	0x0E E8	0x0D

0xAA: R/W byte, R/W decision bit, for write instructions are 0xAA

0x05: Data Length, the length of the data after the R/W decision bit

0x00 20, 0x0E E8, 0x0D occupy a total of 5 bytes, so it is 0x05

0x00 20: Data address bytes, the data address to be transmitted, 0x00 20 is the address of the battery undervoltage protection point

0x0E E8: Data bytes, the data content to be transmitted, check the table 5.4.1.5, you can get the corresponding unit of this command is 0.01V, that is, the decimal number of the data to be transmitted is $43.2/0.01=4320$, and the corresponding hexadecimal number is 0x0E E8

0x0D: Transmit data CRC-8 error detection code, refer to the instructions on CRC-8 in 5.4.1.3, for which the instruction is 0x68

5.4.2.9 Buzzer Shutdown Control

Brief description: Turn off the LAD buzzer function, the corresponding instructions are as follows:

01: Buzzer off

00: Buzzer on

For example:

Turn off the buzzer of the LAD-360DU

Request:

R/W byte	Data Length	Data address bytes	Data bytes	CRC-8
0xAA	0x04	0x00 30	0x01	0x8F

0xAA: R/W byte, R/W decision bit, for write instructions are 0xAA

0x04: Data Length, the length of the data after the R/W bit

0x00 30, 0x01, 0x8F occupy a total of 4 bytes, so it is 0x04

0x00 30: Data address bytes, the address of the data to be transmitted, 0x00 30 is the address where the buzzer turns off control

0x01: Data bytes, the data content to be transmitted, 0x01 the corresponding buzzer is turned off

0x8F: Transmit the data CRC-8 error detection code, refer to the instructions on CRC-8 in 5.4.1.3, for which the instruction is 0x8F

Turn on the buzzer of the LAD-360DU

Request:

R/W byte	Data Length	Data address bytes	Data bytes	CRC-8
0xAA	0x04	0x00 30	0x00	0x88

0xAA: R/W byte, R/W decision bit, for write instructions are 0xAA

0x04: Data Length, the length of the data after the R/W decision bit, occupies 1 byte

0x00 30, 0x00, and 0x88 occupy a total of 4 bytes, so it is 0x04

0x00 30: Data address bytes, the address of the data to be transmitted, 0x00 30 is the address where the buzzer turns off control

0x00: Data bytes, the content of the data to be transmitted, 0x00 the corresponding buzzer is turned off

0x88: Transmit the data CRC-8 error detection code, refer to the instructions on CRC-8 in 5.4.1.3, for which the instruction is 0x88

6. Protections and Failure Correction

6.1 Protections

6.1.1 Output over load protection

Model	Channel	Protection method	
LAD-120	CH1	CH2 is connected to the battery	When CH1 is at 105%~120, it enters UPS mode. When the total output of CH1+CH2 reaches 125%~135%, and it enters hiccup mode(For D type, shuts down output).
		CH2 is not connected to the battery	Enter hiccup mode (D series closes output), can be recovered after restart.
	CH2	Constant current limiting, recovers automatically after fault condition removed. Fault condition does not affect CH1 output. When connected in series with the battery, an external fuse must be installed to protect the battery.	
LAD-240/360/600	CH1	CH2 is connected to the battery	When CH1 is at 105%~120, it enters UPS mode, the total output of CH1+CH2 reaches 125%~135%, and shuts down output.
		CH2 is not connected to the battery	Turn off the output voltage, it can be recovered after restart.
	CH2	Constant current limiting, recovers automatically after fault condition removed. Fault condition does not affect CH1 output. When connected in series with the battery, an external fuse must be installed to protect the battery.	

6.1.2 Over temperature protection

When the automatic turns of the power supply is too high, the power supply off the output. Recycle AC power to recover the output after the power supply cooled down.

6.1.3 Output overvoltage protection

When the output voltage is too high and reaches the OVP protection point, the power supply turns off the output Recycle AC power to recover the output.

Once the LAD-600 triggers the protection, the output recovers after recycling AC power and 3 minutes of cold standby.

6.1.4 Low battery voltage protection

When the battery voltage is too low, the power supply turns off the output.

Model	Battery off voltage
A type	10±0.5V
B type	21.5±0.5V
C type	32±0.5V
D type	43±0.5V

6.1.5 Battery reverse connection protection

When the battery is reversely connected, the power supply is protected against reverse connection by the internal MOSFET, the output of the power supply is turned off, the power supply does not damage, and automatic recover after the abnormal condition is removed.

6.2 Failure Correction

Status	Possible Reason	Method of exclusion
Battery backup function fails	Battery is not connected or the voltage of battery is too low	Check the wiring is good, check whether the battery specifications match the replaced battery
Can't force start	CN2: The wires are not in good contact	Check CN2 Pin 7&8 of LAD-X series or CN2 Pin 1&2 of LAD-xU is well connected
When the AC power supply is normal, it automatically shuts down	OTP	Cool down LAD for 3 minutes before restarting
	OVP	Check whether the battery specifications match
	Short	Restart after eliminating short circuit
The battery is still not fully charged after a long charge	Batteries are aged or damaged	Replace new battery
	Output wire diameter is too thin	Choose appropriate thickness of wire
	Incorrect charging curve setting	Reconfirm the battery charging curve

Note: Please contact MEAN WELL's distributor if above faulty conditions are not corrected.

7.Warranty

This product provides three years warranty under normal usage. Do not replace parts or any form of modification to the product in order to honor the warranty.

※ MEAN WELL reserves the right to change the content of this manual. Please refer to the latest version of our manual on our website. <https://www.meanwell.com>



8.Environmental declaration information

https://www.meanwell.com//Upload/PDF/RoHS_PFOS.pdf
https://www.meanwell.com//Upload/PDF/REACH_SVHC.pdf
https://www.meanwell.com//Upload/PDF/Declaration_RoHS-C.pdf

明緯企業股份有限公司

MEAN WELL ENTERPRISES CO., LTD.

248 新北市五股區五權三路28號
No.28, Wuquan 3rd Rd., Wugu Dist., New Taipei City 248, Taiwan
Tel:886-2-2299-6100 Fax:886-2-2299-6200
<http://www.meanwell.com> E-mail:info@meanwell.com